

FWB4001-J

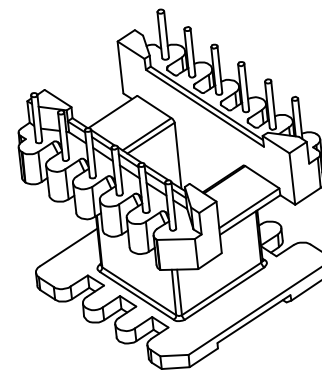
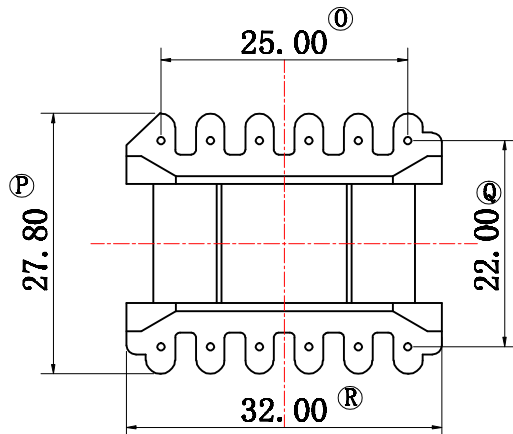
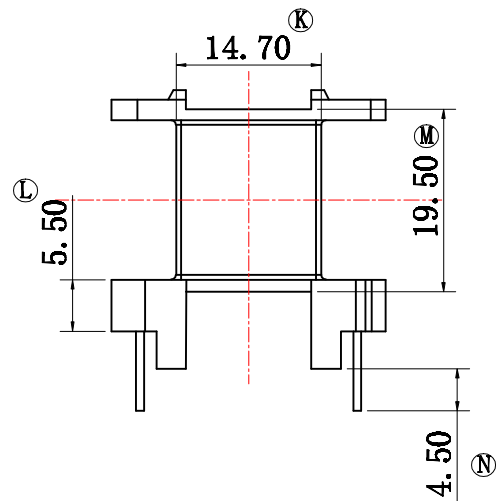
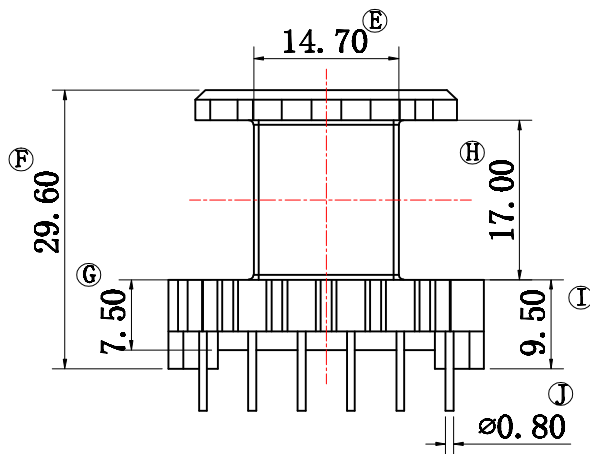
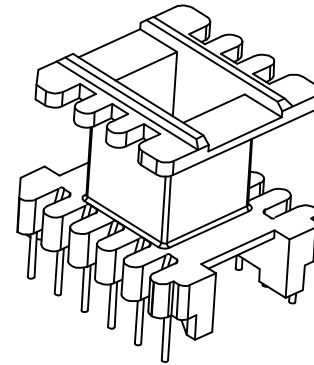
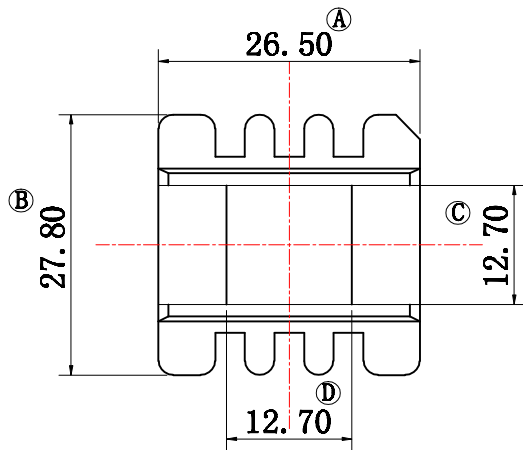

REV	REVISION RECORD	DATE	REV	REVISION RECORD	DATE
A			C		
B			D		

NAME	EE40 6+6P	MATERIAL	PHENOLIC	SCALE	ANGLE	± 1°
DRAWING NO.	FWB4001-J	PIN MATERIAL	CP WIRE	UNIT	m/m	REV
TOLERANCE OF PIN PITCH ± 0.20				HAINING FERRIWO ELECTRONICS CO.,LTD. TEL: +86-573-87088701 FAX: +86-573-87081130 Web: www.ferriwo.com Email: sales@ferriwo.com		
PIN TENSION LOAD kg MN		UL REC: 94V-0				
TOLERANCE: 0<L≤4: ±0.2 4<L≤16: ±0.3 16<L≤63: ±0.4						